

CALIBRADOR NEUMÁTICO EXTERNO



Acople de carrocería 5/16
E-1.01



Acople de carrocería doble
para conector
E-1.02



Acople de carrocería doble
para resorte
E-1.03



Acople de carrocería
para conector 77mm
E-1.04



Acople de carrocería
para conector 95mm
E-1.05



Acople de carrocería
para conector 134 mm
E-1.06



Acople de carrocería
para resorte 77 mm
E-1.07



Acople de carrocería
para resorte 95mm
E-1.08



Acople de carrocería rapido
para resorte 134 mm
E-1.09

CALIBRADOR NEUMÁTICO EXTERNO

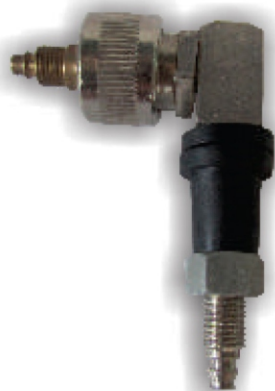
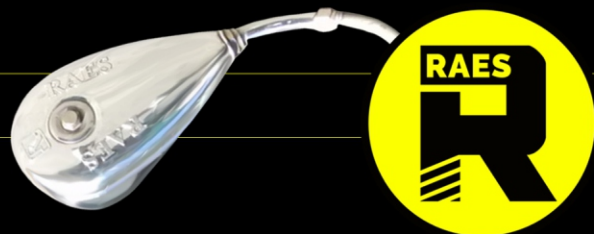

Acople de carrocería rápido
para resorte
E-1.10



Acople de rotor
rosca fina a gruesa
E-1.11



Acople de rotor
rosca fina
E-1.12



Acople de rotor rosca gruesa
E-1.13

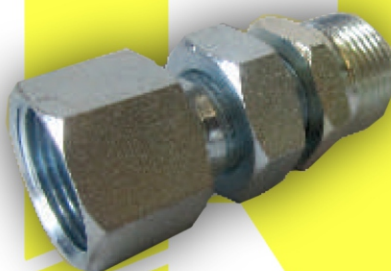

Acople prolongador
variable de rotor
E-1.14



Anillo conector (gris)
E-1.15



Anillo conector (negro)
E-1.16



Arandela para esparragos
E-1.17



Arandela para tapacubrerotor
E-1.18

CALIBRADOR NEUMÁTICO EXTERNO

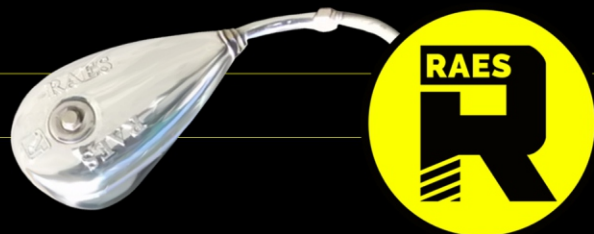

Bajada para conector cromada
E-1.19



Bajada para conector gris
E-1.20



Bajada para resorte cromada
E-1.21



Bajada para resorte gris
E-1.22



Cable alimentación manómetro
E-1.23



Cable alimentación módulo
E-1.24



Cable comunicación
E-1.25



Caño 1 mt
E-1.26.

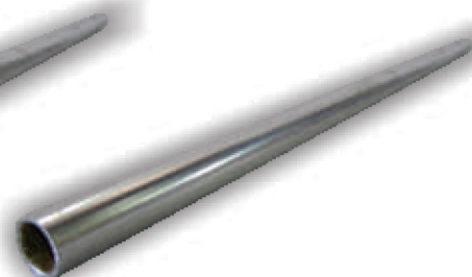

Caño 45 cm
E-1.27

CALIBRADOR NEUMÁTICO EXTERNO

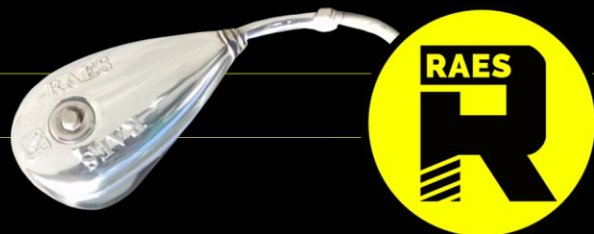

Caño 55 cm
E-1.28



Caño 65 cm
E-1.29



Caño 75 cm
E-1.30

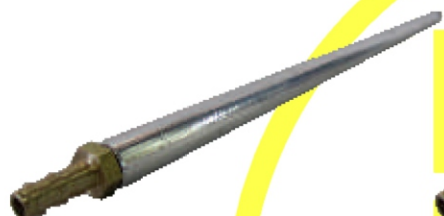

Caño con terminal 1 mt
E-1.31



Caño con terminal 45 cm
E-1.32

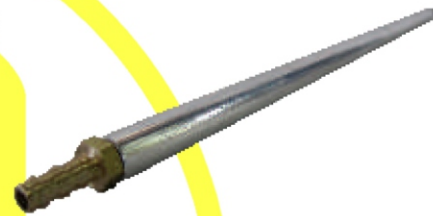

Caño con terminal 55 cm
E-1.33

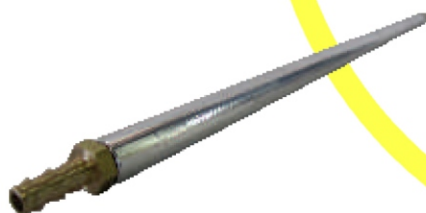

Caño con terminal 65 cm
E-1.34

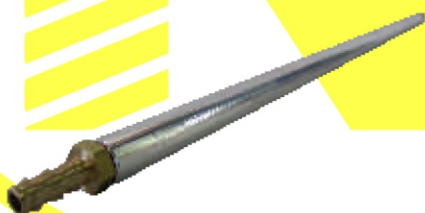

Caño con terminal 75 cm
E-1.35



Caño extensible completo
E-1.36



Caño extensible interno
E-1.37



Codito 1/4
E-1.38



Codito 5/16
E-1.39

CALIBRADOR NEUMÁTICO EXTERNO

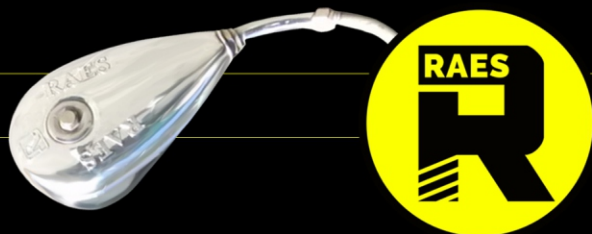

Codo cromado
E-1.40



Codo gris
E-1.41



Conector inferior con virola
E-1.42

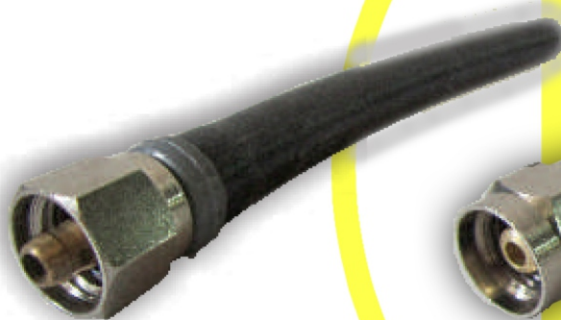

Conector inferior
E-1.43

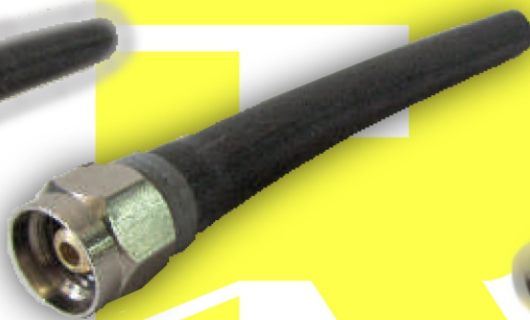

Conector superior
E-1.44



Conexión extrema
E-1.45



Conexión fija
E-1.46

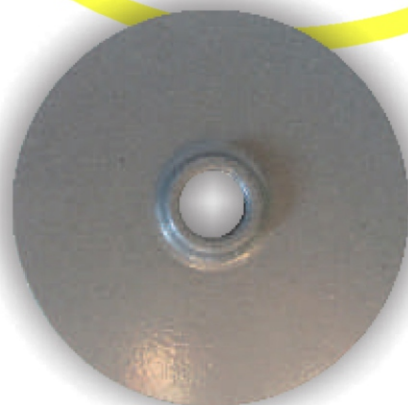

Disco 150 mm
E-1.47



Disco 175 mm
E-1.48

CALIBRADOR NEUMÁTICO EXTERNO



Disco 215 mm
E-1.49



Disco 280 mm
E-1.50



Disco doble t
E-1.51



Disco poliamida
para graseira MB delantera
E-1.52

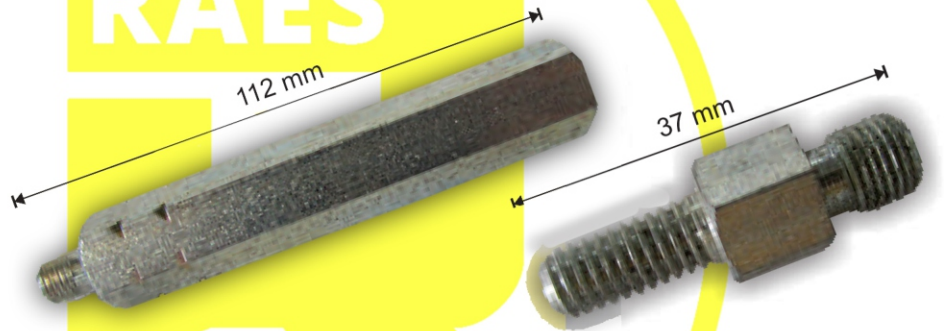

Esparrago Cummins
Fiat Eurocargo - Attack
Cavalino - Stralis - Cursor
E-1.53

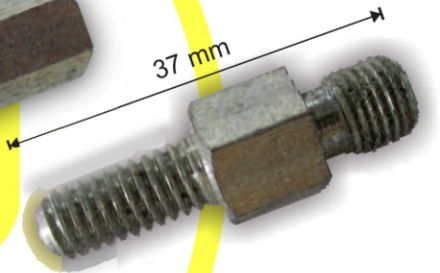

Esparrago doble rosca 5/16
E-1.54

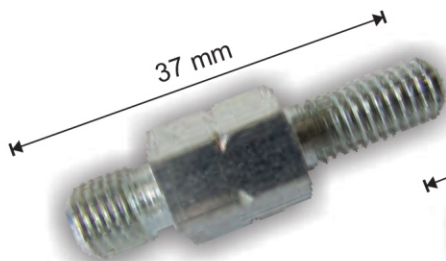

Esparrago doble rosca
8x1.25 métrico
E-1.55

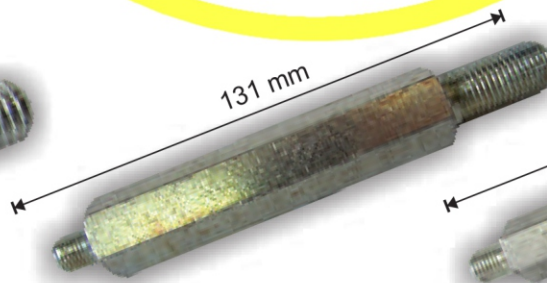

Esparrago Fiat 619
Eurotracker - Eurotech -190
E-1.56

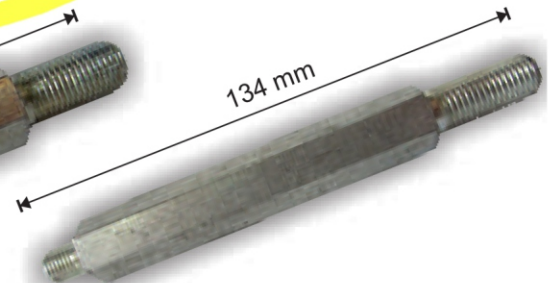

Esparrago Ford 915
Deutz agrale
E-1.57

CALIBRADOR NEUMÁTICO EXTERNO

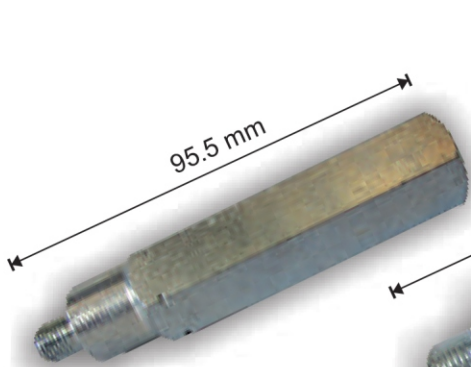

95.5 mm

Esparrago Ford cargo
Volkswaguen
E-1.58

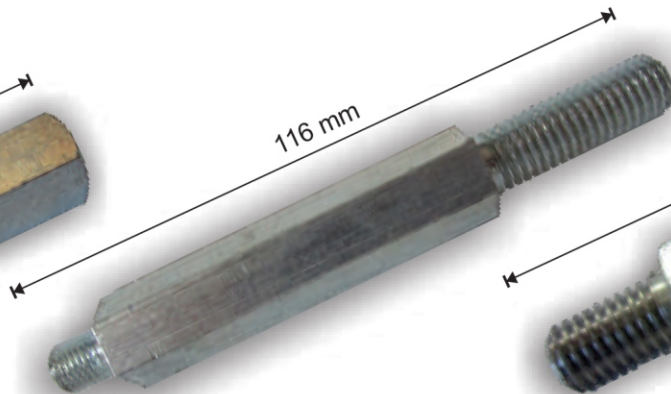

116 mm

Esparrago MB 1115
MB 1315 masa chica
E-1.59

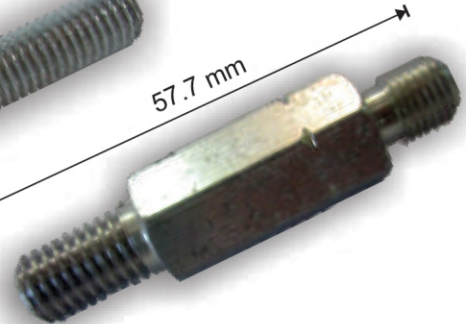

57.7 mm

Esparrago MB 1938
E-1.60

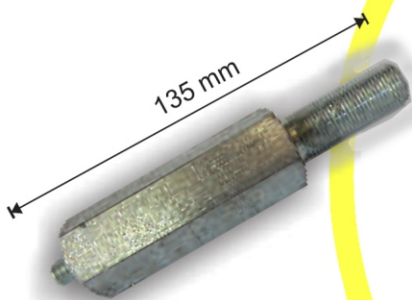

135 mm

Esparrago MB axor
trasero 1933
E-1.61



71.5 mm

Esparrago MB delantero
1720 - Atego - Axor
E-1.62

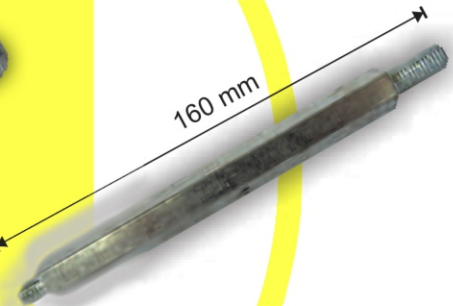

160 mm

Esparrago Miley
E-1.63

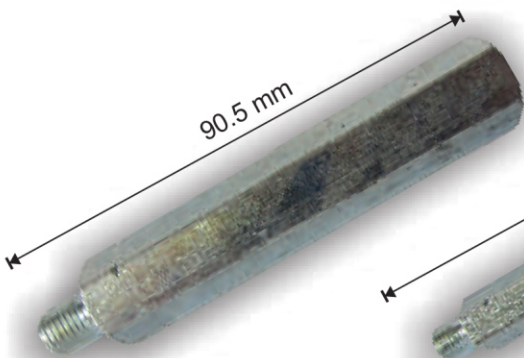

90.5 mm

Esparrago OA 101 Deutz
E-1.64

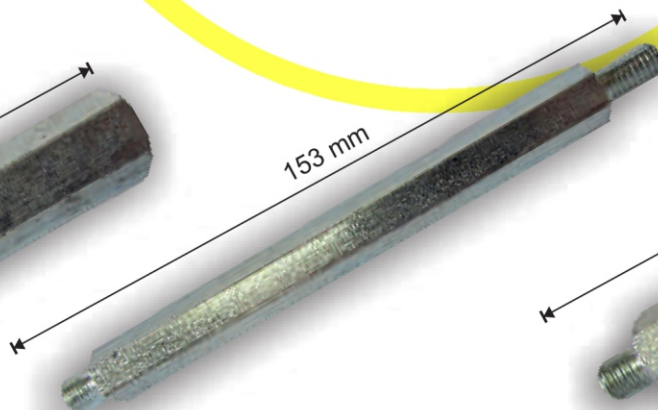

153 mm

Esparrago OH MB 1620
1420 - 1618 - 1720 -1518
E-1.65

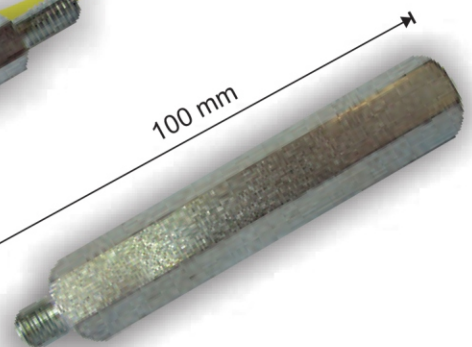

100 mm

Esparrago OKR
1621 - Ford 4000
E-1.66

CALIBRADOR NEUMÁTICO EXTERNO

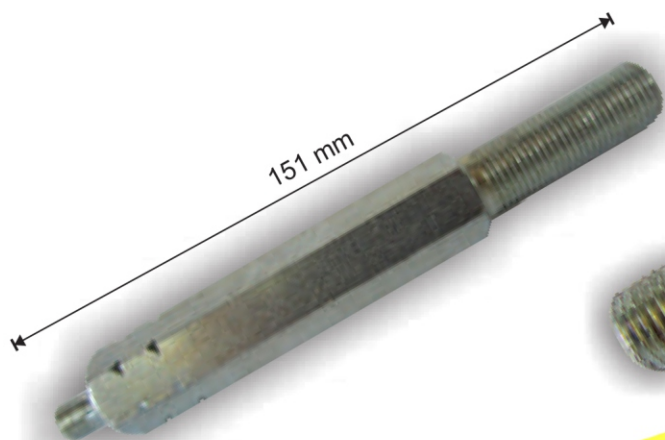
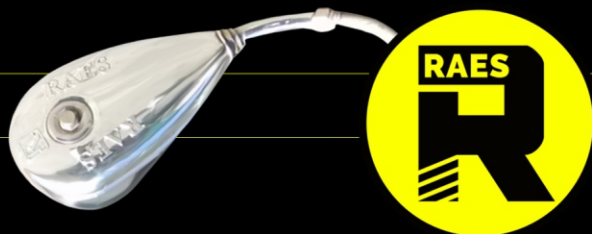

Esparrago OM 500 - Atego
E-1.67



Esparrago prolongador 20 mm
E-1.68



Esparrago prolongador 30 mm
E-1.69

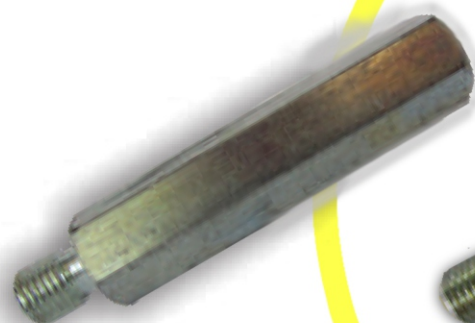

Esparrago prolongador 40mm
E-1.70



Esparrago prolongador 60 mm
E-1.71

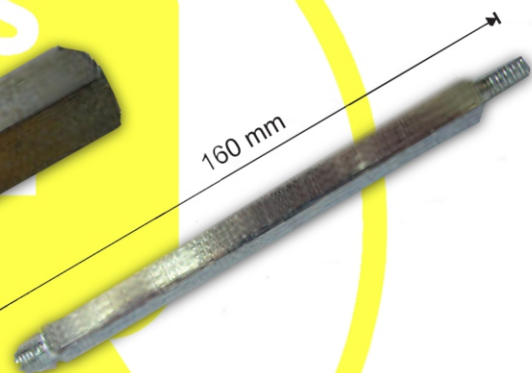

Esparrago Random
E-1.72

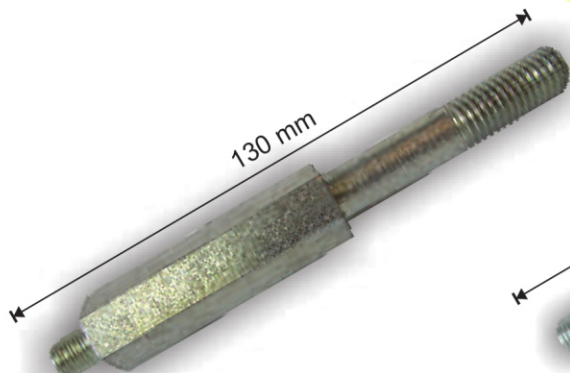

Esparrago Renault
E-1.73

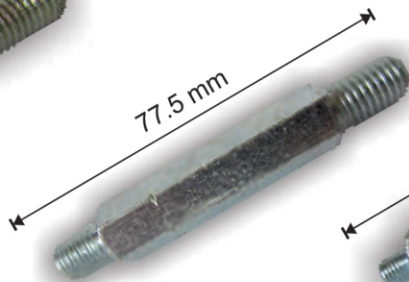

Esparrago Scania delantero
E-1.74

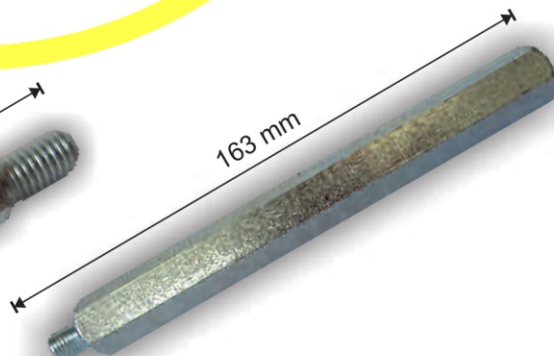

Esparrago Scania trasero
E-1.75

CALIBRADOR NEUMÁTICO EXTERNO



Esparrago taza decorativa
Volkswagen delantero
Ford delantero
E-1.76

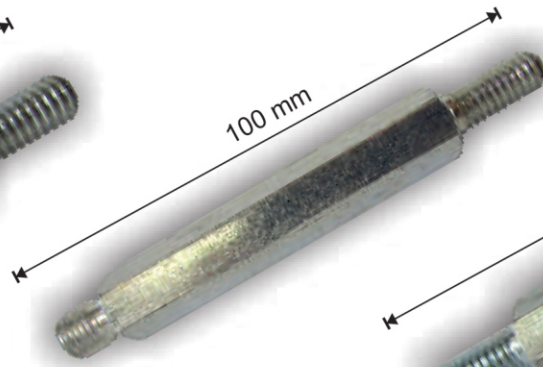

Esparrago
taza roscada nf
E-1.77

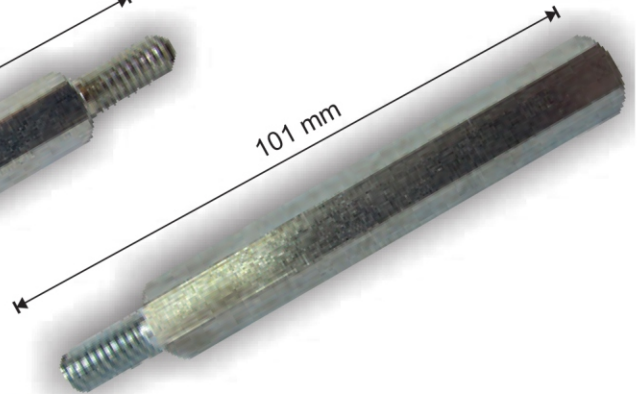

Esparrago
taza roscada tornillo
E-1.78

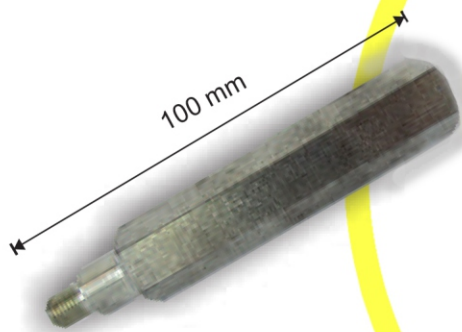

Esparrago Volvo - Renault 330
E-1.79



Espiralada completa
E-1.80



Espiralada simple
E-1.81



Estrella para colectivo okr
E-1.82



Estrella para tapa roscada semi
E-1.83



Filtro
E-1.84

CALIBRADOR NEUMÁTICO EXTERNO

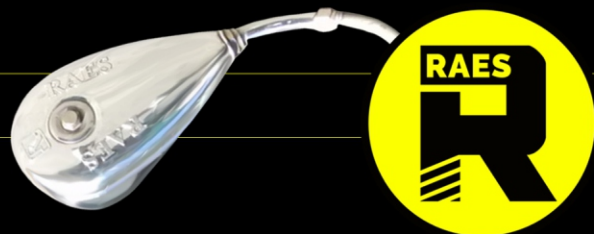

Grampa para chasis
E-1.85



Grampa para manguera
E-1.86

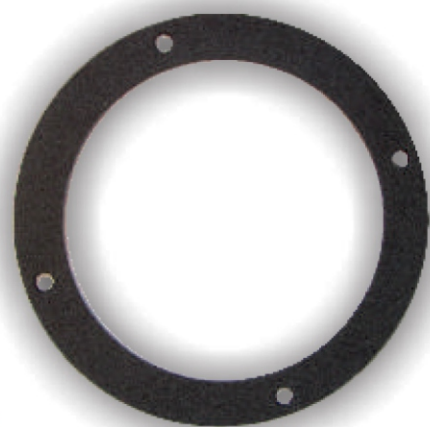

Junta 4 agujeros
para tapa semi random
E-1.87



Junta 5 agujeros
para tapa semi ciega
E-1.88



Junta 6 agujeros
para tapa ciega
E-1.89



Junta 8 agujeros
E-1.90



Junta para grasera okr
E-1.91



Kit modulo 1 presión 12v.
E-1.92



Kit modulo 1 presión 24v.
E-1.93

CALIBRADOR NEUMÁTICO EXTERNO

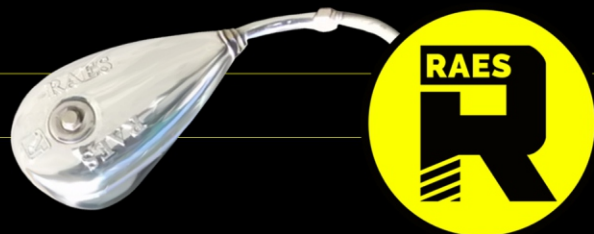

Kit módulo 2 presiones 12v.
E-1.94



Kit módulo 2 presiones 24v.
E-1.95



Kit módulo 3 presiones 12v.
E-1.96



Kit módulo 3 presiones 24v.
E-1.97



Manguera poliamida 5/16
E-1.98



Manguera módulo
E-1.99



Manguera poliamida 1/4
E-1.100



Manguera transparente
E-1.101



Máscara 2 relojes 5 teclas
E-1.102

CALIBRADOR NEUMÁTICO EXTERNO

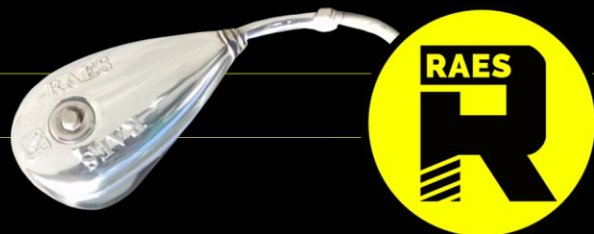

Máscara 3 relojes
5 teclas MB 1634
E-1.103



Máscara 3 relojes
Fiat Cavalino
E-1.104



Máscara 3 relojes
MB axor-atego
E-1.105



Máscara 3 relojes scania 340
E-1.106



Máscara 3 relojes Scania
E-1.107



Máscara scania 2 relojes
E-1.108



Módulo 1 presión 12v.
E-1.109



Módulo 1 presión 24v.
E-1.110



Módulo 2 presiones 12v.
E-1.111

CALIBRADOR NEUMÁTICO EXTERNO



Módulo 2 presiones 24v.
E-1.112



Módulo 3 presiones 12v.
E-1.113



Módulo 3 presiones 24v.
E-1.114



Niple 143
E-1.115



Niple 243
E-1.116



Pico para aire
E-1.117



Pico para caño
E-1.118



Planchuela 814
E-1.119

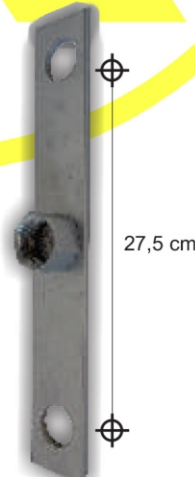

Planchuela 1115 recta
E-1.163



Planchuela 1315 curva
E-1.120

CALIBRADOR NEUMÁTICO EXTERNO

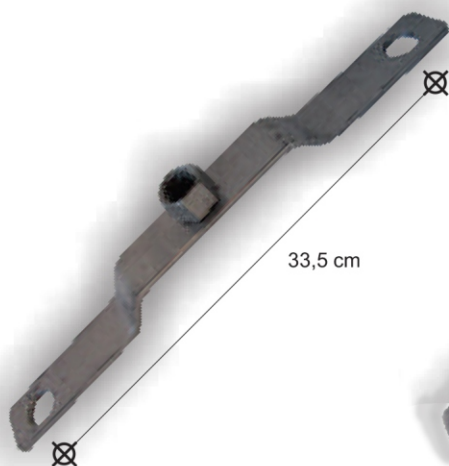

Planchuela oh curva
E-1.121

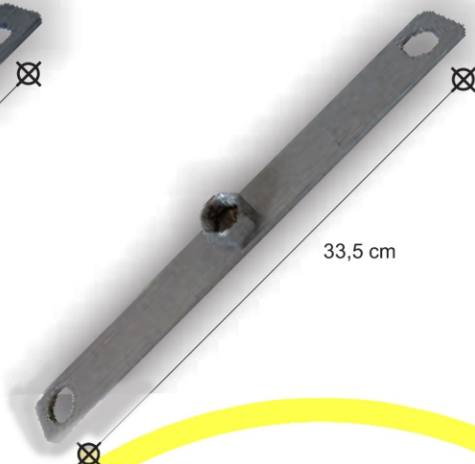

Planchuela recta
E-1.122



Punta espiralada
E-1.123



Reductor 1/4 a 5/16
E-1.124



Reductor 3/8 a 1/4
E-1.125



Reductor 3/8 a 5/16
E-1.126



Reductor 5/16 a 1/4
E-1.127



Resorte
E-1.128



Rotor
E-1.129

CALIBRADOR NEUMÁTICO EXTERNO

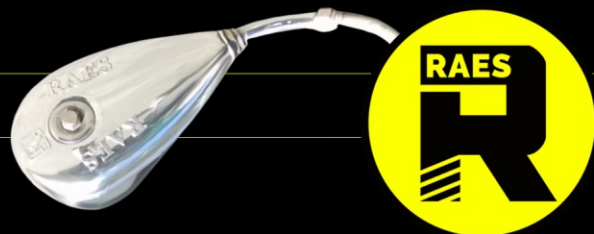

Soporte L
para acople de carroceria
E-1.130



Soporte taza decorativa
E-1.131



Soporte unidad de lectura
E-1.132



Tapa cubrerotor gris
E-1.133



Tapa cubrerotor
con curva cromada
E-1.134



Tapa cubrerotor
con curva gris
E-1.135



Tapa cubrerotor cromada
E-1.136



Tapa grasera oh delantera
E-1.137



Tapa okr delantera
E-1.138

CALIBRADOR NEUMÁTICO EXTERNO

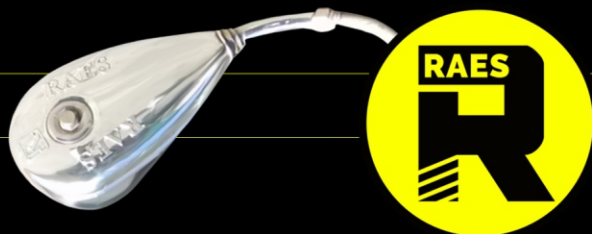

Tapa roscada cono
E-1.139



Tapa roscada
para esparrago y estrella
E-1.140



Tapa semi ciega
E-1.141



Tapa semi prisionera
E-1.142



Tapón 1/4
E-1.143



Tapón 5/16
E-1.144



Tapón 243
para acople de carrocería
E-1.145



Tapón de goma
para tapa roscada semi
E-1.146



Tuerca 1/4
E-1.147

CALIBRADOR NEUMÁTICO EXTERNO



Tuerca 5/16
E-1.148



Tuerca Hexagonal para codo
E-1.149



Tuerca nf
E-1.150



Tuerca resorte
E-1.151



Unidad de lectura
E-1.152



Unión cruz 1/4 bronce
E-1.153



Unión doble bronce 1/4
E-1.154



Unión doble bronce 5/16
E-1.155



Unión rápida bronce 1/4
E-1.156

CALIBRADOR NEUMÁTICO EXTERNO

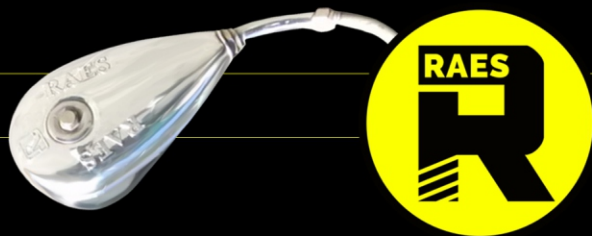

Unión recta 1/4
E-1.157



Unión T 1/4
E-1.158



Válvula codo
NE-1.159



Válvula corta
E-1.160



Válvula larga
E-1.161



Virola para conector inferior
E-1.162